



Valde

								
Symbol		Wymiary					Waga Obj. Opak.	Elementy składowe
		W1	W2	D1	D2	H		
LAV96L		920	454			1105	53.9 kg 0.178 m3 5 szt.	LAN8L+LA09L+LAN7P

Dodatkowa dopłata						

								
Symbol		Wymiary					Waga Obj. Opak.	Elementy składowe
		W1	W2	D1	D2	H		
LAV95L		920	917			1105	97 kg 0.252 m3 6 szt.	LAN2L+LA09L+LAN1P
LAV75L		1366	917			1105	114.95 kg 0.326 m3 6 szt.	LAN2L+LA13L+LAN1P
LAV76L		1666	917			1105	128.85 kg 0.373 m3 6 szt.	LAN2L+LA16L+LAN1P
LAV77L		2366	917			1105	155.9 kg 0.497 m3 7 szt.	LAN2L+LA23L+LAN1P

Dodatkowa dopłata						
Półka pod monitor x1						
	X					
	X					
	X					

.mdd

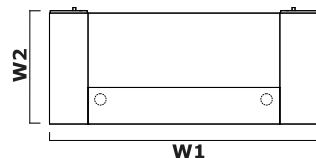
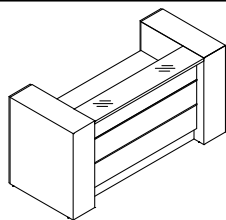

Symbol		Wymiary					Waga Obj. Opak.	Elementy składowe
		W1	W2	D1	D2	H		
LAV01L		1926	937			1105	167.55 kg 0.973 m3 8 szt.	LAD10+LAL10+LA13L+LAP10 +LAD10
LAV02L		2226	937			1105	181.45 kg 1.02 m3 8 szt.	LAD10+LAL10+LA16L+LAP10 +LAD10
LAV03L		2926	937			1105	208.5 kg 1.145 m3 9 szt.	LAD10+LAL10+LA23L+LAP10 +LAD10

Dodatkowa dopłata						
Półka pod monitor x1						
X						
X						
X						

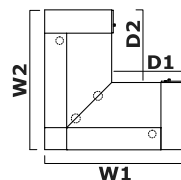
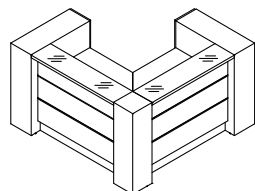

Symbol		Wymiary					Waga Obj. Opak.	Elementy składowe
		W1	W2	D1	D2	H		
LAV10L		1908	1908	991	991	1105	238.65 kg 1.374 m3 14 szt.	LAD10+LAL10+LAL13L+LA100+LAP13L+LAP10+LAD10+NL41
LAV11L		1908	2208	991	1291	1105	251.95 kg 1.421 m3 14 szt.	LAD10+LAL10+LAL13L+LA100+LAP16L+LAP10+LAD10+NL41
LAV12L		1908	2908	991	1991	1105	279.05 kg 1.546 m3 15 szt.	LAD10+LAL10+LAL13L+LA100+LAP23L+LAP10+LAD10+NL41
LAV13L		2208	1908	1291	991	1105	252.4 kg 1.421 m3 14 szt.	LAD10+LAL10+LAL16L+LA100+LAP13L+LAP10+LAD10+NL41
LAV14L		2208	2208	1291	1291	1105	265.7 kg 1.468 m3 14 szt.	LAD10+LAL10+LAL16L+LA100+LAP16L+LAP10+LAD10+NL41
LAV15L		2208	2908	1291	1991	1105	292.8 kg 1.593 m3 15 szt.	LAD10+LAL10+LAL16L+LA100+LAP23L+LAP10+LAD10+NL41

Dodatkowa dopłata						
Półka pod monitor x1	Półka pod monitor x 2					
X	X					
X	X					
X	X					
X	X					
X	X					

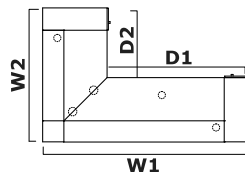
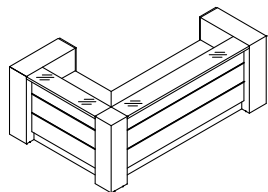

Symbol		Wymiary					Waga Obj. Opak.	Elementy składowe
		W1	W2	D1	D2	H		
LAV16L		2908	1908	1991	991	1105	279.55 kg 1.546 m ³ 15 szt.	LAD10+LAL10+LAL23L+LA100 +LAP13L+LAP10+LAD10+NL41
LAV17L		2908	2208	1991	1291	1105	292.85 kg 1.593 m ³ 15 szt.	LAD10+LAL10+LAL23L+LA100 +LAP16L+LAP10+LAD10+NL41
LAV18L		2908	2908	1991	1991	1105	319.95 kg 1.717 m ³ 16 szt.	LAD10+LAL10+LAL23L+LA100 +LAP23L+LAP10+LAD10+NL41

Dodatkowa dopłata						
Półka pod monitor x1	Półka pod monitor x 2					
X	X					
X	X					
X	X					

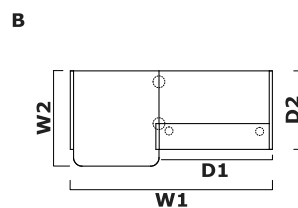
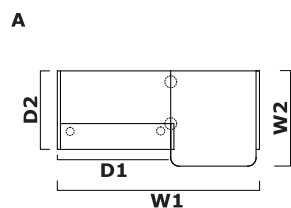
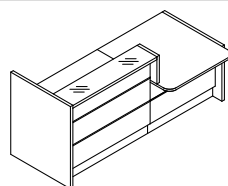

Symbol			Wymiary					Waga Obj. Opak.	Elementy składowe
A	B		W1	W2	D1	D2	H		
LAV19L	LAV20L		2366	1114	1328	917	1105	152.3 kg 0.509 m ³ 12 szt.	A - LAN6L+LAU11L+LAN4L+LA13L+LAN1P+NL41 B - LAN2L+LA13L+LAN3P+LAU11L +LAN5P+NL41
LAV21L	LAV22L		2666	1114	1628	917	1105	166.2 kg 0.556 m ³ 12 szt.	A - LAN6L+LAU11L+LAN4L+LA16L+LAN1P+NL41 B - LAN2L+LA16L+LAN3P+LAU11L +LAN5P+NL41
LAV23L	LAV24L		3366	1114	2318	917	1105	193.25 kg 0.68 m ³ 13 szt.	A - LAN6L+LAU11L+LAN4L+LA23L+LAN1P+NL41 B - LAN2L+LA23L+LAN3P+LAU11L +LAN5P+NL41
LAV191L	LAV201L		2166	1114	1328	917	1105	145.05 kg 0.486 m ³ 12 szt.	A - LAN6L+LAU18L+LAN4L+LA13L +LAN1P+NL41 B - LAN2L+LA13L+LAN3P+LAU18L +LAN5P+NL41
LAV211L	LAV221L		2466	1114	1628	917	1105	158.95 kg 0.533 m ³ 12 szt.	A - LAN6L+LAU18L+LAN4L+LA16L +LAN1P+NL41 B - LAN2L+LA16L+LAN3P+LAU18L +LAN5P+NL41
LAV231L	LAV241L		3166	1114	2318	917	1105	186 kg 0.657 m ³ 13 szt.	A - LAN6L+LAU18L+LAN4L+LA23L +LAN1P+NL41 B - LAN2L+LA23L+LAN3P+LAU18L +LAN5P+NL41

Dodatkowa dopłata						
Półka pod monitor x1						
X						
X						
X						
X						
X						
X						

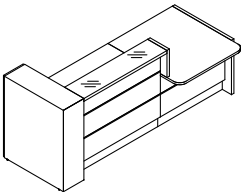
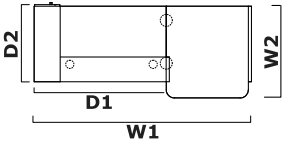
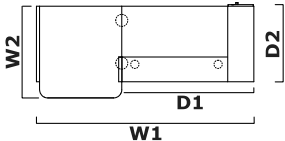
				A			B							
														
Symbol		Wymiary					Waga Obj. Opak.	Elementy składowe	Dodatkowa dopłata					
A	B	W1	W2	D1	D2	H			Półka pod monitor x1					
LAV41L	LAV42L	2646	1134	1608	937	1105	178.4 kg 0.833 m ³ 13 szt.	A - LAN6L+LAU11L+LAN4L+LA13L+LAP10+LAD10+NL41 B - LAD10+LAL10+LA13L+LAN3P +LAU11L+LAN5P+NL41	X					
LAV43L	LAV44L	2946	1134	1908	937	1105	192.3 kg 0.88 m ³ 13 szt.	A - LAN6L+LAU11L+LAN4L+LA16L+LAP10+LAD10+NL41 B - LAD10+LAL10+LA16L+LAN3P +LAU11L+LAN5P+NL41	X					
LAV45L	LAV46L	3646	1134	2608	937	1105	219.35 kg 1.004 m ³ 14 szt.	A - LAN6L+LAU11L+LAN4L+LA23L+LAP10+LAD10+NL41 B - LAD10+LAL10+LA23L+LAN3P +LAU11L+LAN5P+NL41	X					
LAV411L	LAV421L	2446	1134	1608	937	1105	171.15 kg 0.809 m ³ 13 szt.	A - LAN6L+LAU18L+LAN4L+LA13L +LAP10+LAD10+NL41 B - LAD10+LAL10+LA13L+LAN3P +LAU18L+LAN5P+NL41	X					
LAV431L	LAV441L	2746	1134	1908	937	1105	185.05 kg 0.856 m ³ 13 szt.	A - LAN6L+LAU18L+LAN4L+LA16L +LAP10+LAD10+NL41 B - LAD10+LAL10+LA16L+LAN3P +LAU18L+LAN5P+NL41	X					
LAV451L	LAV461L	3446	1134	2608	937	1105	212.1 kg 0.981 m ³ 14 szt.	A - LAN6L+LAU18L+LAN4L+LA23L +LAP10+LAD10+NL41 B - LAD10+LAL10+LA23L+LAN3P +LAU18L+LAN5P+NL41	X					

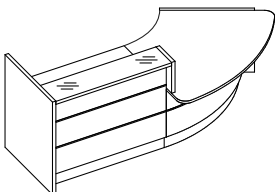
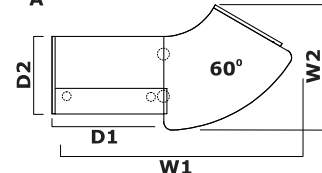
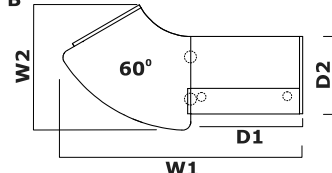
				A			B							
														
Symbol		Wymiary					Waga Obj. Opak.	Elementy składowe	Dodatkowa dopłata					
A	B	W1	W2	D1	D2	H			Półka pod monitor x1					
LAV88L	LAV89L	2845	1486	1328	917	1105	164.2 kg 0.832 m ³ 12 szt.	A - LAN6L+LAV66L+LAN4L+LA13L+LAN1P+NL41 B - LAN2L+LA13L+LAN3P+LAV66L+LAN5P+NL41	X					
LAV91L	LAV92L	3145	1486	1628	917	1105	178.1 kg 0.879 m ³ 12 szt.	A - LAN6L+LAV66L+LAN4L+LA16L+LAN1P+NL41 B - LAN2L+LA16L+LAN3P+LAV66L+LAN5P+NL41	X					

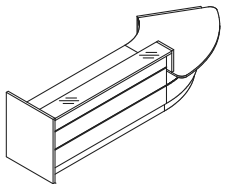
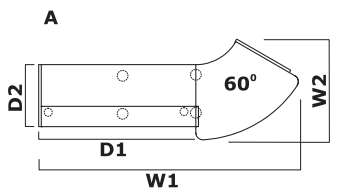
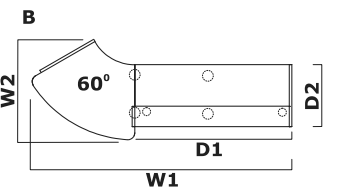
Symbol		Wymiary					Waga Obj. Opak.	Elementy składowe
A	B	W1	W2	D1	D2	H		
LAV93L	LAV94L	3845	1486	2318	917	1105	205.15 kg 1.003 m ³ 13 szt.	A - LAN6L+LAV66L+LAN4L+LA23L+LAN1P+NL41 B - LAN2L+LA23L+LAN3P+LAV66L+LAN5P+NL41

Dodatkowa dopłata					
Półka pod monitor x1					
	X				

Symbol		Wymiary					Waga Obj. Opak.	Elementy składowe
A	B	W1	W2	D1	D2	H		
LAV84L	LAV85L	2443	1489	1404	1114	1105	157.5 kg 0.957 m ³ 12 szt.	A - LAN2L+LAV64L+LAN3P+LAU11L +LAN5P+NL41 B - LAN6L+LAU11L+LAN4L+LAV64L +LAN1P+NL41
LAV841L	LAV851L	2243	1489	1404	1114	1105	150.25 kg 0.934 m ³ 12 szt.	A - LAN2L+LAV64L+LAN3P+LAU18L+LAN5P+NL41 B - LAN6L+LAU18L+LAN4L+LAV64L+LAN1P+NL41

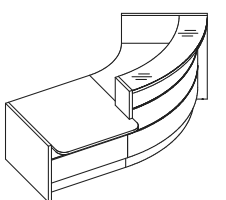
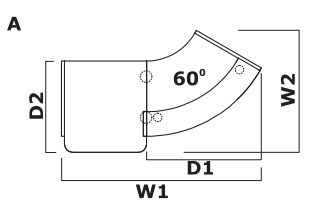
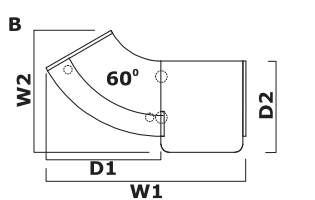
Dodatkowa dopłata					
Półka pod monitor x1					
	X				
Półka pod monitor x1					
	X				

Symbol		Wymiary					Waga Obj. Opak.	Elementy składowe
A	B	W1	W2	D1	D2	H		
LAV86L	LAV87L	2638	1835	1600	937	1105	203.9 kg 1.328 m ³ 13 szt.	A - LAN2L+LAV90L+LAN3P+LAU11L +LAN5P+NL41 B - LAN6L+LAU11L+LAN4L+LAV90L +LAN1P+NL41
LAV861L	LAV871L	2438	1835	1600	937	1105	196.65 kg 1.305 m ³ 13 szt.	A - LAN2L+LAV90L+LAN3P+LAU18L+LAN5P+NL41 B - LAN6L+LAU18L+LAN4L+LAV90L+LAN1P+NL41

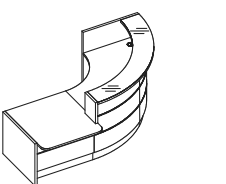
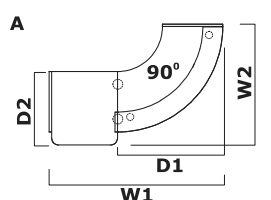
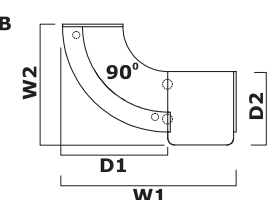
Dodatkowa dopłata					
Półka pod monitor x1					
	X				
Półka pod monitor x1					
	X				

		A						B					
Symbol		Wymiary					Waga Obj. Opak.	Elementy składowe					
A	B	W1	W2	D1	D2	H							
LAV30L	LAV31L	2922	1486			1105	169.9 kg 1.28 m ³ 12 szt.	A - LAN6L+LAV66L+LAN4L+LAV64L +LAN1P+NL41 B - LAN2L+LAV64L+LAN3P+LAV66L +LAN5P+NL41					

Dodatkowa dopłata					
Półka pod monitor x1					
	X				

		A						B					
Symbol		Wymiary					Waga Obj. Opak.	Elementy składowe					
A	B	W1	W2	D1	D2	H							
LAV32L	LAV33L	3452	1502	1720	1225	1105	183.5 kg 1.366 m ³ 13 szt.	A - LAN6L+LAV66L+LAN4L+LAV62L +LAN1P+NL41 B - LAN2L+LAV62L+LAN3P+LAV66L +LAN5P+NL41					

Dodatkowa dopłata					
Półka pod monitor x1					
	X				

		A						B					
Symbol		Wymiary					Waga Obj. Opak.	Elementy składowe					
A	B	W1	W2	D1	D2	H							
LAV34L	LAV35L	4195	1835			1503	1105	262.75 kg 2.129 m ³ 20 szt.	A - LAN2L+LAV62L+LAN3P+LAV66L +LAN4L+LAV64L+LAN1P+2xNL41 B - LAN2L+LAV64L+LAN3P+LAV66L +LAN4L+LAV62L+LAN1P+2xNL41				

Dodatkowa dopłata					
Półka pod monitor x1	Półka pod monitor x 2				
		X	X		

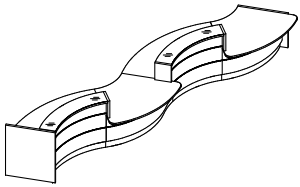
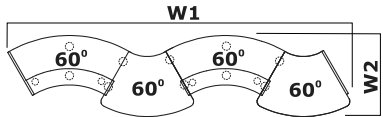
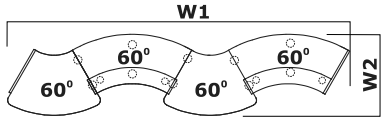
		A					B				
											
Symbol		Wymiary					Waga Obj. Opak.	Elementy składowe			
A	B	W1	W2	D1	D2	H					
LAV36L	LAV37L	6352	1503			1105	322.6 kg 2.715 m ³ 26 szt.	A - LAN6L+2xLAV66L+2xLAN4L+2xLAV62L+LAN3P+LAN1P +3xNL41 B - LAN2L+2xLAV62L+2xLAN3P+2xLAV66L+LAN4L+LAN5P +3xNL41			

Dodatkowa dopłata					
Półka pod monitor x1	Półka pod monitor x 2				
X	X				

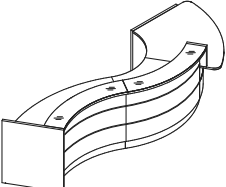
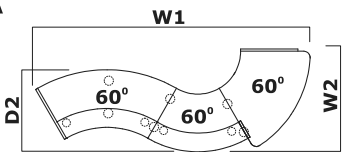
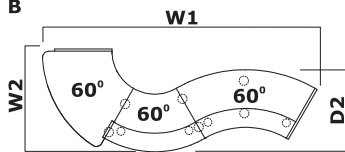
		A					B				
											
Symbol		Wymiary					Waga Obj. Opak.	Elementy składowe			
A	B	W1	W2	D1	D2	H					
LAV38L	LAV39L	4386	1639		1307	1105	249.75 kg 2.106 m ³ 19 szt.	A - LAN6L+LAV66L+LAN4L+LAV64L +LAV62L+LAN1P+2xNL41 B - LAN2L+LAV62L+LAV64L+LAN3P +LAV66L+LAN5P+2xNL41			

Dodatkowa dopłata					
Półka pod monitor x1	Półka pod monitor x 2				
X	X				

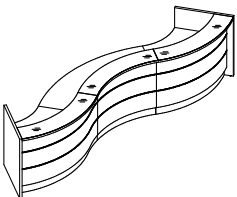
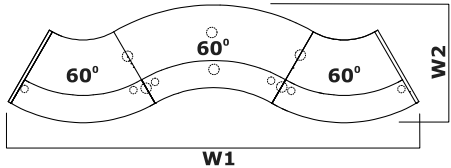
											
Symbol		Wymiary					Waga Obj. Opak.	Elementy składowe			
A	B	W1	W2	D1	D2	H					
LAV50L		4566	1307			1105	260.15 kg 2.329 m ³ 17 szt.	LAN2L+2xLAV64L+LAV62L+LAN1P+2xNL41			

Dodatkowa dopłata					
Półka pod monitor x1	Półka pod monitor x 2	Półka pod monitor x 3			
X	X	X			

Symbol		Wymiary					Waga Obj. Opak.	Elementy składowe
		W1	W2	D1	D2	H		
LAV51L		3202	3006			1105	415.2 kg 3.741 m ³ 27 szt.	LAN2L+2xLAV64L+2xLAV90L +LAN1P+3xNL41

Dodatkowa dopłata					
Półka pod monitor x1	Półka pod monitor x 2	Półka pod monitor x 3	Półka pod monitor x 4		
X	X	X	X		

Symbol		Wymiary					Waga Obj. Opak.	Elementy składowe
		W1	W2	D1	D2	H		
LAV52L		3202	1639			1105	282.7 kg 2.261 m ³ 15 szt.	LAN2L+2xLAV90L+LAN1P+NL41

Dodatkowa dopłata					
Półka pod monitor x1	Półka pod monitor x 2				
X	X				

Symbol		Wymiary					Waga Obj. Opak.	Elementy składowe
		W1	W2	D1	D2	H		
LAV61L		3202	1919			1105	329.5 kg 2.898 m ³ 15 szt.	LAD10+LAL10+2xLAV90L+LAP10+LAD10+NL41

Dodatkowa dopłata					
Półka pod monitor x1	Półka pod monitor x 2				
X	X				

Symbol		Wymiary					Waga Obj. Opak.	Elementy składowe
		W1	W2	D1	D2	H		
LAV04L		3202	3006			1105	239 kg 2.312 m3 23 szt.	LAN8L+2xLAV70L+2xLAV64L +LAN7P+3xNL41

Dodatkowa dopłata						
Półka pod monitor x1	Półka pod monitor x 2					
X	X					

Symbol		Wymiary					Waga Obj. Opak.	Elementy składowe
		W1	W2	D1	D2	H		
LAV53L		2317	1145			1105	170.05 kg 1.15 m3 8 szt.	LAN2L+LAV90L+LAN1P

Dodatkowa dopłata						
Półka pod monitor x1						
X						

Symbol		Wymiary					Waga Obj. Opak.	Elementy składowe
		W1	W2	D1	D2	H		
LAV73L		2713	1353			1105	222.65 kg 1.798 m3 10 szt.	LAD10+LAL10+LAV90L+LAP10+LAD10

Dodatkowa dopłata						
Półka pod monitor x1						
X						

Symbol		Wymiary					Waga Obj. Opak.	Elementy składowe
		W1	W2	D1	D2	H		
LAV54L		1666	1029			1105	123.65 kg 0.779 m ³ 7 szt.	LAN2L+LAV64L+LAN1P

Dodatkowa dopłata						
Półka pod monitor x1						
	X					

Symbol		Wymiary					Waga Obj. Opak.	Elementy składowe
		W1	W2	D1	D2	H		
LAV74L		2151	1183			1105	176.25 kg 1.427 m ³ 9 szt.	LAD10+LAL10+LAV64L+LAP10+LAD10

Dodatkowa dopłata						
Półka pod monitor x1						
	X					

Symbol		Wymiary					Waga Obj. Opak.	Elementy składowe
		W1	W2	D1	D2	H		
LAV78L	LAV79L	2733	1292	1328	917	1105	184.2 kg 1.071 m ³ 13 szt.	A - LAN2L+LAV64L+LA13L+LAN1P+NL41 B - LAN2L+LA13L+LAV64L+LAN1P+NL41
LAV80L	LAV81L	3033	1292	1628	917	1105	198.1 kg 1.118 m ³ 13 szt.	A - LAN2L+LAV64L+LA16L+LAN1P+NL41 B - LAN2L+LA16L+LAV64L+LAN1P+NL41
LAV82L	LAV83L	3733	1292	2318	917	1105	225.15 kg 1.242 m ³ 14 szt.	A - LAN2L+LAV64L+LA23L+LAN1P+NL41 B - LAN2L+LA23L+LAV64L+LAN1P+NL41

Dodatkowa dopłata						
Półka pod monitor x1	Półka pod monitor x 2					
		X	X			
X	X					
X	X					

Symbol		Wymiary					Waga Obj. Opak.	Elementy składowe		
A	B	W1	W2	D1	D2	H				
LAV55L	LAV56L	3208	1918	1608	937	1105	283.2 kg 2.089 m ³ 16 szt.	A - LAD10+LAL10+LAV90L+LA13L+LAP10+LAD10+NL41 B - LAD10+LAL10+LA13L+LAV90L+LAP10+LAD10+NL41	X	X
LAV57L	LAV58L	3508	1918	1908	937	1105	297.1 kg 2.137 m ³ 16 szt.	A - LAD10+LAL10+LAV90L+LA16L+LAP10+LAD10+NL41 B - LAD10+LAL10+LA16L+LAV90L+LAP10+LAD10+NL41	X	X

Dodatkowa dopłata					
Półka pod monitor x1	Półka pod monitor x 2				
X	X				
X	X				

Symbol		Wymiary					Waga Obj. Opak.	Elementy składowe		
A	B	W1	W2	D1	D2	H				
LAV59L	LAV60L	4208	1918	2608	937	1105	324.15 kg 2.261 m ³ 17 szt.	A - LAD10+LAL10+LAV90L+LA23L+LAP10+LAD10+NL41 B - LAD10+LAL10+LA23L+LAV90L+LAP10+LAD10+NL41	X	X

Dodatkowa dopłata					
Półka pod monitor x1	Półka pod monitor x 2				
X	X				

Symbol		Wymiary					Waga Obj. Opak.	Elementy składowe		
A	B	W1	W2	D1	D2	H				
LAV107L		3437	2437	2318	1328	1105	256.55 kg 1.121 m ³ 18 szt.	LAN2L+LA13L+LAN3P+LAV68L+LAN4L+LA23L+LAN1P+2xNL41	X	X
LAV108L		3437	2737	2318	1628	1105	270.45 kg 1.168 m ³ 18 szt.	LAN2L+LA16L+LAN3P+LAV68L+LAN4L+LA23L+LAN1P+2xNL41	X	X
LAV109L		3437	3437	2318	2318	1105	297.5 kg 1.293 m ³ 19 szt.	LAN2L+LA23L+LAN3P+LAV68L+LAN4L+LA23L+LAN1P+2xNL41	X	X

Dodatkowa dopłata					
Półka pod monitor x1	Półka pod monitor x 2				
X	X				
X	X				
X	X				

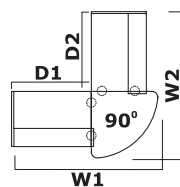
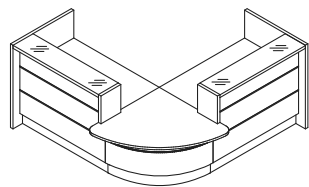

Symbol		Wymiary					Waga Obj. Opak.	Elementy składowe
		W1	W2	D1	D2	H		
LAV101L		2437	2437	1328	1328	1105	215.6 kg 0.95 m ³ 17 szt.	LAN2L+LA13L+LAN3P+LAV68L+LAN4L+LA13L+LAN1P+2xNL41
LAV102L		2437	2737	1328	1628	1105	229.5 kg 0.997 m ³ 17 szt.	LAN2L+LA16L+LAN3P+LAV68L+LAN4L+LA13L+LAN1P+2xNL41
LAV103L		2437	3437	1328	2318	1105	256.55 kg 1.121 m ³ 18 szt.	LAN2L+LA23L+LAN3P+LAV68L+LAN4L+LA13L+LAN1P+2xNL41
LAV104L		2737	2437	1628	1328	1105	229.5 kg 0.997 m ³ 17 szt.	LAN2L+LA13L+LAN3P+LAV68L+LAN4L+LA16L+LAN1P+2xNL41
LAV105L		2737	2737	1628	1628	1105	243.4 kg 1.044 m ³ 17 szt.	LAN2L+LA16L+LAN3P+LAV68L+LAN4L+LA16L+LAN1P+2xNL41
LAV106L		2737	3437	1628	2318	1105	270.45 kg 1.168 m ³ 18 szt.	LAN2L+LA23L+LAN3P+LAV68L+LAN4L+LA16L+LAN1P+2xNL41

Dodatkowa dopłata						
Półka pod monitor x1	Półka pod monitor x 2					
X	X					
X	X					
X	X					
X	X					
X	X					
X	X					

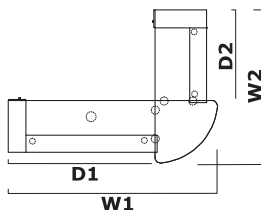
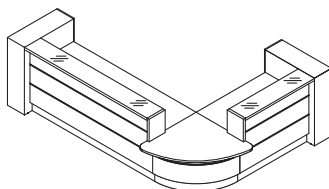

Symbol		Wymiary					Waga Obj. Opak.	Elementy składowe
		W1	W2	D1	D2	H		
LAV122L		3717	2717	2608	1608	1105	309.15 kg 1.769 m ³ 20 szt.	LAD10+LAL10+LA13L+LAN3P +LAV68L+LAN4L+LA23L+LAP10 +LAD10+2xNL41
LAV123L		3717	3017	2608	1908	1105	323.05 kg 1.816 m ³ 20 szt.	LAD10+LAL10+LA16L+LAN3P +LAV68L+LAN4L+LA23L+LAP10 +LAD10+2xNL41
LAV124L		3717	3717	2608	2608	1105	350.1 kg 1.94 m ³ 21 szt.	LAD10+LAL10+LA23L+LAN3P +LAV68L+LAN4L+LA23L+LAP10 +LAD10+2xNL41

Dodatkowa dopłata						
Półka pod monitor x1	Półka pod monitor x 2					
X	X					
X	X					
X	X					

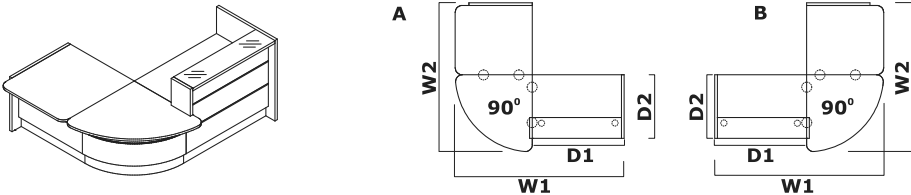

Symbol		Wymiary	Waga Obj. Opak.	Elementy składowe				
A	B				W1	W2	D1	D2
LAV110L	LAV111L	2442	2147	1328	917	1105	187.3 kg 0.832 m ³ 16 szt.	A - LAN2L+LA13L+LAN3P+LAV68L+LAU11L+LAN5P+2xNL41 B - LAN6L+LAU11L+LAV68L+LAN4L +LA13L+LAN1P+2xNL41
LAV112L	LAV113L	2742	2147	1628	917	1105	201.2 kg 0.879 m ³ 16 szt.	A - LAN2L+LA16L+LAN3P+LAV68L+LAU11L+LAN5P+2xNL41 B - LAN6L+LAU11L+LAV68L+LAN4L +LA16L+LAN1P+2xNL41
LAV114L	LAV115L	3442	2147	2318	917	1105	228.25 kg 1.004 m ³ 17 szt.	A - LAN2L+LA23L+LAN3P+LAV68L+LAU11L+LAN5P+2xNL41 B - LAN6L+LAU11L+LAV68L+LAN4L +LA23L+LAN1P+2xNL41
LAV1101L	LAV1111L	2442	1947	1328	917	1105	180.05 kg 0.809 m ³ 16 szt.	A - LAN2L+LA13L+LAN3P+LAV68L+LAU18L+LAN5P+2xNL41 B - LAN6L+LAU18L+LAV68L+LAN4L+LA13L+LAN1P+2xNL41
LAV1121L	LAV1131L	2742	1947	1628	917	1105	193.95 kg 0.856 m ³ 16 szt.	A - LAN2L+LA16L+LAN3P+LAV68L+LAU18L+LAN5P+2xNL41 B - LAN6L+LAU18L+LAV68L+LAN4L+LA16L+LAN1P+2xNL41
LAV1141L	LAV1151L	3442	1947	2318	917	1105	221 kg 0.98 m ³ 17 szt.	A - LAN2L+LA23L+LAN3P+LAV68L+LAU18L+LAN5P+2xNL41 B - LAN6L+LAU18L+LAV68L+LAN4L+LA23L+LAN1P+2xNL41

Dodatkowa dopłata						
Półka pod monitor x1						
X						
X						
X						
X						
X						

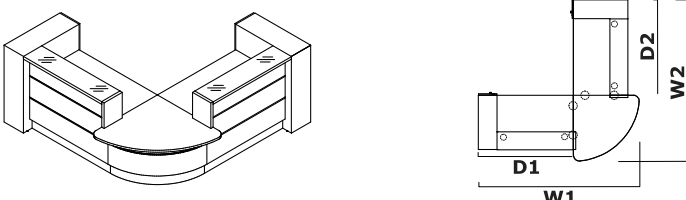

Symbol		Wymiary	Waga Obj. Opak.	Elementy składowe				
					W1	W2	D1	D2
LAV116L		2717	2717	1608	1608	1105	268.2 kg 1.597 m ³ 19 szt.	LAD10+LAL10+LA13L+LAN3P +LAV68L+LAN4L+LA13L+LAP10 +LAD10+2xNL41
LAV117L		2717	3017	1608	1908	1105	282.1 kg 1.644 m ³ 19 szt.	LAD10+LAL10+LA16L+LAN3P +LAV68L+LAN4L+LA13L+LAP10 +LAD10+2xNL41
LAV118L		2717	3717	1608	2608	1105	309.15 kg 1.769 m ³ 20 szt.	LAD10+LAL10+LA23L+LAN3P +LAV68L+LAN4L+LA13L+LAP10 +LAD10+2xNL41
LAV119L		3017	2717	1908	1608	1105	282.1 kg 1.644 m ³ 19 szt.	LAD10+LAL10+LA13L+LAN3P +LAV68L+LAN4L+LA16L+LAP10 +LAD10+2xNL41

Dodatkowa dopłata						
Półka pod monitor x1	Półka pod monitor x 2					
X	X					
X	X					
X	X					
X	X					

Symbol	Wymiary	W1	W2	D1	D2	H	Waga Obj. Opak.	Elementy składowe
LAV121L	3017	3717	1908	2608	1105	323.05 kg 1.816 m ³ 20 szt.	LAD10+LAL10+LA23L+LAN3P +LAV68L+LAN4L+LA16L+LAP10 +LAD10+2xNL41	

Dodatkowa dopłata					
Półka pod monitor x1	Półka pod monitor x 2				
X	X				
X	X				

Symbol		Wymiary	W1	W2	D1	D2	H	Waga Obj. Opak.	Elementy składowe
A	B								
LAV125L	LAV126L	2722	2147	1608	1038	1105	216.8 kg 1.162 m ³ 17 szt.	A - LAD10+LAL10+LA13L+LAN3P +LAV68L+LAU11L+LAN5P+2xNL41 B - LAN6L+LAU11L+LAV68L+LAN4L +LA13L+LAP10+LAD10+2xNL41	
LAV127L	LAV128L	3022	2147	1908	1038	1105	224.7 kg 1.198 m ³ 16 szt.	A - LAD10+LAL10+LA16L+LAN3P +LAV68L+LAU11L+LAN5P+2xNL41 B - LAN6L+LAU11L+LAV68L+LAN4L +LA16L+LAP10+LAD10+2xNL41	
LAV129L	LAV130L	3722	2147	2608	1038	1105	251.75 kg 1.322 m ³ 17 szt.	A - LAD10+LAL10+LA23L+LAN3P +LAV68L+LAU11L+LAN5P+2xNL41 B - LAN6L+LAU11L+LAV68L+LAN4L +LA23L+LAP10+LAD10+2xNL41	
LAV1251L	LAV1261L	2722	1947	1608	838	1105	209.55 kg 1.138 m ³ 17 szt.	A - LAD10+LAL10+LA13L+LAN3P +LAV68L+LAU18L+LAN5P+2xNL41 B - LAN6L+LAU18L+LAV68L+LAN4L+LA13L+LAP10+LAD10+2xNL41	
LAV1271L	LAV1281L	3022	1947	1908	838	1105	217.45 kg 1.175 m ³ 16 szt.	A - LAD10+LAL10+LA16L+LAN3P+LAV68L+LAU18L+LAN5P+2xNL41 B - LAN6L+LAU18L+LAV68L+LAN4L+LA16L+LAP10+LAD10+2xNL41	
LAV1291L	LAV1301L	3722	1947	2608	838	1105	244.5 kg 1.299 m ³ 17 szt.	A - LAD10+LAL10+LA23L+LAN3P +LAV68L+LAU18L+LAN5P+2xNL41 B - LAN6L+LAU18L+LAV68L+LAN4L+LA23L+LAP10+LAD10+2xNL41	

Dodatkowa dopłata					
Półka pod monitor x1					
X					
X					
X					
X					
X					
X					

Symbol		Wymiary					Waga Obj. Opak.	Elementy składowe
		W1	W2	D1	D2	H		
LAV131L		2245	2245	1328	1328	1105	214 kg 1.036 m ³ 16 szt.	LAN2L+LA13L+LAV70L+LA13L+LAN1P+2xNL41
LAV132L		2245	2545	1328	1628	1105	227.9 kg 1.083 m ³ 16 szt.	LAN2L+LA16L+LAV70L+LA13L+LAN1P+2xNL41
LAV133L		2245	3245	1328	2318	1105	254.95 kg 1.208 m ³ 17 szt.	LAN2L+LA23L+LAV70L+LA13L+LAN1P+2xNL41

Dodatkowa dopłata						
Półka pod monitor x1	Półka pod monitor x 2					
X	X					
X	X					
X	X					

Symbol		Wymiary					Waga Obj. Opak.	Elementy składowe
		W1	W2	D1	D2	H		
LAV134L		2545	2245	1628	1328	1105	227.9 kg 1.083 m ³ 16 szt.	LAN2L+LA13L+LAV70L+LA16L+LAN1P+2xNL41
LAV135L		2545	2545	1628	1628	1105	241.8 kg 1.13 m ³ 16 szt.	LAN2L+LA16L+LAV70L+LA16L+LAN1P+2xNL41
LAV136L		2545	3245	1628	2318	1105	268.85 kg 1.255 m ³ 17 szt.	LAN2L+LA23L+LAV70L+LA16L+LAN1P+2xNL41

Dodatkowa dopłata						
Półka pod monitor x1	Półka pod monitor x 2					
X	X					
X	X					
X	X					

Symbol		Wymiary					Waga Obj. Opak.	Elementy składowe
		W1	W2	D1	D2	H		
LAV137L		3245	2245	2318	1328	1105	254.95 kg 1.208 m ³ 17 szt.	LAN2L+LA13L+LAV70L+LA23L+LAN1P+2xNL41
LAV138L		3245	2545	2318	1628	1105	268.85 kg 1.255 m ³ 17 szt.	LAN2L+LA16L+LAV70L+LA23L+LAN1P+2xNL41
LAV139L		3245	3245	2318	2318	1105	295.9 kg 1.379 m ³ 18 szt.	LAN2L+LA23L+LAV70L+LA23L+LAN1P+2xNL41

Dodatkowa dopłata						
Półka pod monitor x1	Półka pod monitor x 2					
X	X					
X	X					
X	X					

Symbol		Wymiary					Waga Obj. Opak.	Elementy składowe
		W1	W2	D1	D2	H		
LAV140L	LAV141L	2442	1955	1328	1038	1105	193.3 kg 0.933 m ³ 17 szt.	A - LAN2L+LA13L+LAV70L+LAN3P+LAU11L+LAN5P+2xNL41 B - LAN6L+LAU11L+LAN4L+LAV70L +LA13L+LAN1P+2xNL41
LAV142L	LAV143L	2742	1955	1628	1038	1105	207.2 kg 0.98 m ³ 17 szt.	A - LAN2L+LA16L+LAV70L+LAN3P+LAU11L+LAN5P+2xNL41 B - LAN6L+LAU11L+LAN4L+LAV70L +LA16L+LAN1P+2xNL41
LAV1401L	LAV1411L	2442	1755	1328	838	1105	186.05 kg 0.91 m ³ 17 szt.	A - LAN2L+LA13L+LAV70L+LAN3P+LAU18L+LAN5P+2xNL41 B - LAN6L+LAU18L+LAN4L+LAV70L+LA13L+LAN1P+2xNL41
LAV1421L	LAV1431L	2742	1755	1628	838	1105	199.95 kg 0.957 m ³ 17 szt.	A - LAN2L+LA16L+LAV70L+LAN3P+LAU18L+LAN5P+2xNL41 B - LAN6L+LAU18L+LAN4L+LAV70L+LA16L+LAN1P+2xNL41

Dodatkowa dopłata						
Półka pod monitor x1						
X						
X						
X						
X						

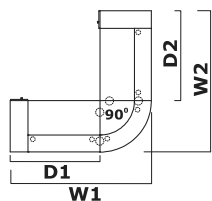
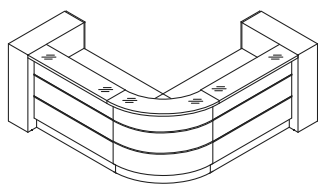

Symbol		Wymiary					Waga Obj. Opak.	Elementy składowe
		W1	W2	D1	D2	H		
LAV146L		2525	2525	1608	1608	1105	266.6 kg 1.684 m ³ 18 szt.	LAD10+LAL10+LA13L+LAV70L+LA13L+LAP10+LAD10+2xNL41
LAV147L		2525	2825	1608	1908	1105	280.5 kg 1.731 m ³ 18 szt.	LAD10+LAL10+LA16L+LAV70L+LA13L+LAP10+LAD10+2xNL41
LAV148L		2525	3525	1608	2608	1105	307.55 kg 1.855 m ³ 19 szt.	LAD10+LAL10+LA23L+LAV70L+LA13L+LAP10+LAD10+2xNL41
LAV149L		2825	2525	1908	1608	1105	280.5 kg 1.731 m ³ 18 szt.	LAD10+LAL10+LA13L+LAV70L+LA16L+LAP10+LAD10+2xNL41
LAV150L		2825	2825	1908	1908	1105	294.4 kg 1.778 m ³ 18 szt.	LAD10+LAL10+LA16L+LAV70L+LA16L+LAP10+LAD10+2xNL41
LAV151L		2825	3525	1908	2608	1105	321.45 kg 1.902 m ³ 19 szt.	LAD10+LAL10+LA23L+LAV70L+LA16L+LAP10+LAD10+2xNL41

Dodatkowa dopłata					
Półka pod monitor x1	Półka pod monitor x 2				
X	X				
X	X				
X	X				
X	X				
X	X				
X	X				

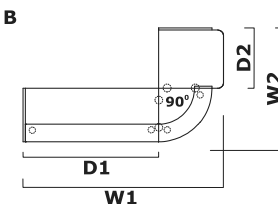
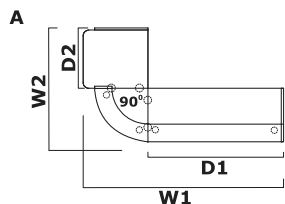
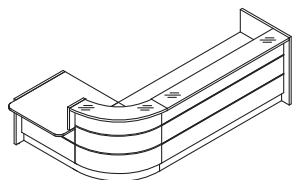

Symbol			Wymiary					Waga Obj. Opak.	Elementy składowe
A	B		W1	W2	D1	D2	H		
LAV144L	LAV145L		3442	1955	2318	1038	1105	234.25 kg 1.104 m ³ 18 szt.	A - LAN2L+LA23L+LAV70L+LAN3P+LAU11L+LAN5P+2xNL41 B - LAN6L+LAU11L+LAN4L+LAV70L +LA23L+LAN1P+2xNL41
LAV1441L	LAV1451L		3442	1755	2318	838	1105	227 kg 1.081 m ³ 18 szt.	A - LAN2L+LA23L+LAV70L+LAN3P+LAU18L+LAN5P+2xNL41 B - LAN6L+LAU18L+LAN4L+LAV70L+LA23L+LAN1P+2xNL41

Dodatkowa dopłata					
Półka pod monitor x1					
X					
X					

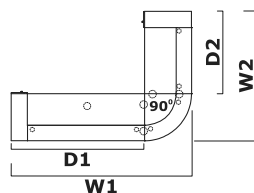
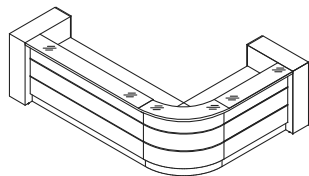

Symbol		Wymiary					Waga Obj. Opak.	Elementy składowe
		W1	W2	D1	D2	H		
LAV152L		3525	2525	2608	1608	1105	307.55 kg 1.855 m ³ 19 szt.	LAD10+LAL10+LA13L+LAV70L+LA23L+LAP10+LAD10+2xNL41
LAV153L		3525	2825	2608	1908	1105	321.45 kg 1.902 m ³ 19 szt.	LAD10+LAL10+LA16L+LAV70L+LA23L+LAP10+LAD10+2xNL41
LAV154L		3525	3525	2608	2608	1105	348.5 kg 2.027 m ³ 20 szt.	LAD10+LAL10+LA23L+LAV70L+LA23L+LAP10+LAD10+2xNL41

Dodatkowa dopłata						
Półka pod monitor x1	Półka pod monitor x 2					
X	X					
X	X					
X	X					

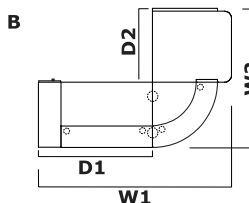
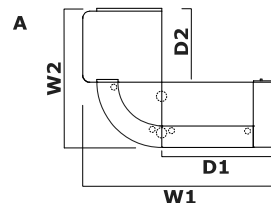
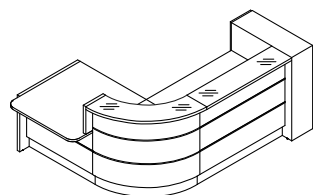

Symbol			Wymiary					Waga Obj. Opak.	Elementy składowe
A	B		W1	W2	D1	D2	H		
LAV155L	LAV156L		2722	1955	1608	1038	1105	216.8 kg 1.251 m ³ 17 szt.	A - LAD10+LAL10+LA13L+LAV70L+LAN3P+LAU11L+LAN5P+2xNL41 B - LAN6L+LAU11L+LAN4L+LAV70L +LA13L+LAP10+LAD10+2xNL41
LAV157L	LAV158L		3022	1955	1908	1038	1105	230.7 kg 1.299 m ³ 17 szt.	A - LAD10+LAL10+LA16L+LAV70L+LAN3P+LAU11L+LAN5P+2xNL41 B - LAN6L+LAU11L+LAN4L+LAV70L +LA16L+LAP10+LAD10+2xNL41
LAV159L	LAV160L		3722	1955	2608	1038	1105	257.75 kg 1.423 m ³ 18 szt.	A - LAD10+LAL10+LA23L+LAV70L+LAN3P+LAU11L+LAN5P+2xNL41 B - LAN6L+LAU11L+LAN4L+LAV70L +LA23L+LAP10+LAD10+2xNL41
LAV1551L	LAV1561L		2722	1755	1608	838	1105	209.55 kg 1.228 m ³ 17 szt.	A - LAD10+LAL10+LA13L+LAV70L+LAN3P+LAU18L+LAN5P+2xNL41 B - LAN6L+LAU18L+LAN4L+LAV70L+LA13L+LAP10+LAD10+2xNL41
LAV1571L	LAV1581L		3022	1755	1908	838	1105	223.45 kg 1.275 m ³ 17 szt.	A - LAD10+LAL10+LA16L+LAV70L+LAN3P+LAU18L+LAN5P+2xNL41 B - LAN6L+LAU18L+LAN4L+LAV70L+LA16L+LAP10+LAD10+2xNL41
LAV1591L	LAV1601L		3722	1755	2608	838	1105	250.5 kg 1.4 m ³ 18 szt.	A - LAD10+LAL10+LA23L+LAV70L+LAN3P+LAU18L+LAN5P+2xNL41 B - LAN6L+LAU18L+LAN4L+LAV70L+LA23L+LAP10+LAD10+2xNL41

Dodatkowa dopłata						
Półka pod monitor x1						
X						
X						
X						
X						
X						

Symbol		Wymiary					Waga Obj. Opak.	Elementy składowe
		W1	W2	D1	D2	H		
LAV05L		3589	1629			1105	215.65 kg 1.781 m ³ 17 szt.	LAN6L+2xLAV66L+LAN4L+LAV64L+LAN3P+LAN5P+2xNL41

Dodatkowa dopłata					
Półka pod monitor x1					
X					

Symbol		Wymiary					Waga Obj. Opak.	Elementy składowe
		W1	W2	D1	D2	H		
LAV06L	LAV07L	4199	1629			1105	269.75 kg 2.345 m ³ 20 szt.	A - LAN2L+2xLAV64L+LAV62L+LAN1P+2xNL41 B - LAN2L+LAV62L+2xLAV64L+LAN1P+2xNL41

Dodatkowa dopłata					
Półka pod monitor x1	Półka pod monitor x2	Półka pod monitor x3			
X	X	X			

Symbol		Wymiary					Waga Obj. Opak.	Elementy składowe
		W1	W2	D1	D2	H		
LAV08L	LAV09L	3367	1629			1105	229.25 kg 2.009 m ³ 16 szt.	A - LAN2L+2xLAV64L+LAN3P+LAV66L+LAN5P+2xNL41 B - LAN6L+LAV66L+LAN4L+2xLAV64L+LAN1P+2xNL41

Dodatkowa dopłata					
Półka pod monitor x1	Półka pod monitor x2				
X	X				

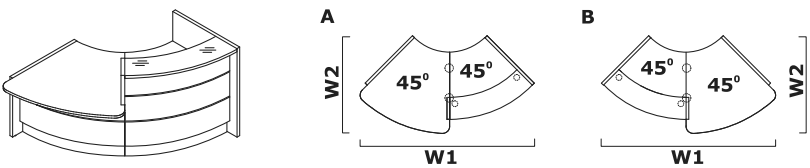

Symbol		Wymiary					Waga Obj. Opak.	Elementy składowe
A	B	W1	W2	D1	D2	H		
LAV161L	LAV162L	2320	1114			1105	142.55 kg 0.95 m3 11 szt.	A - LAN2L+LAV63L+LAN3P+LAV65L +LAN5P+NL41 B - LAN6L+LAV65L+LAN4L+LAV63L +LAN1P+NL41

Dodatkowa dopłata					

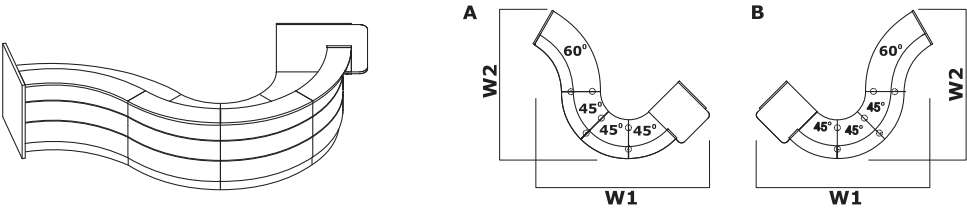

Symbol		Wymiary					Waga Obj. Opak.	Elementy składowe
A	B	W1	W2	D1	D2	H		
LAV163L	LAV164L	4080	3540			1105	333.25 kg 2.675 m3 27 szt.	A - LAN6L+LAU11L+LAN4L+3xLAV63L+LAV62L+LAN1P+4xNL41 B - LAN2L+LAV62L+3xLAV63L+LAN3P+LAU11L+LAN5P+4xNL41
LAV1631L	LAV1641L	4080	3540			1105	326 kg 2.651 m3 27 szt.	A - LAN6L+LAU18L+LAN4L +3xLAV63L+LAV62L+LAN1P+4xNL41 B - LAN2L+LAV62L+3xLAV63L+LAN3P+LAU18L+LAN5P+4xNL41

Dodatkowa dopłata					
Półka pod monitor x1					
X					
X					

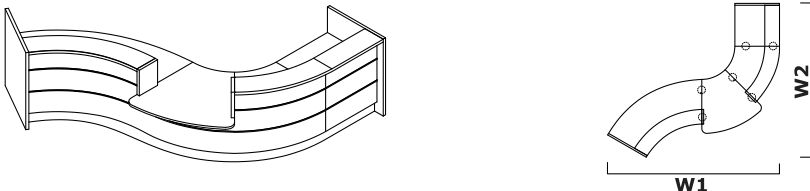



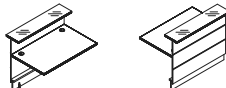
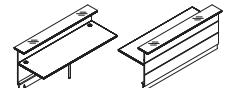
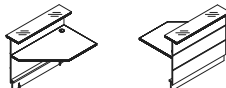
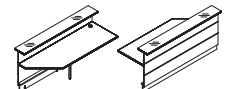
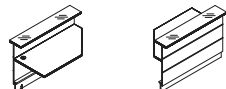
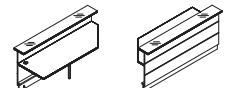
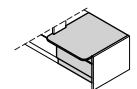

Symbol		Wymiary					Waga Obj. Opak.	Elementy składowe
A		W1	W2	D1	D2	H		
LAV165L		2790	3946			1105	273.5 kg 1.948 m3 23 szt.	LAN2L+LAV62L+LAN3P+LAV65L +LAN4L+LAV63L+LA09L+LAN1P +3xNL41

Dodatkowa dopłata					
Półka pod monitor x1					
X					

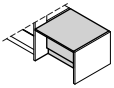
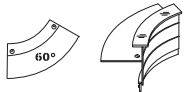

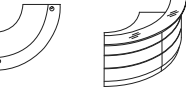
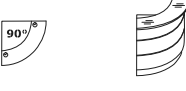
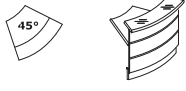



Elementy składowe proste							
	Symbol		Wymiary			Waga Obj. Opak.	Uwagi
			Szer.	Gł.	Wys.		
	LA09L		844	917	1105	37.6 kg 0.149 m3 4 szt.	
	LA13L		1290	917	1105	55.55 kg 0.223 m3 4 szt.	
	LA16L		1590	917	1105	69.45 kg 0.27 m3 4 szt.	
	LA23L		2290	917	1105	96.5 kg 0.395 m3 5 szt.	blat zawsze z nogą NE41, kolor M015 - biały półmat
	LAP13L		1290	917	1105	52.2 kg 0.223 m3 4 szt.	
	LAP16L		1590	917	1105	65.5 kg 0.27 m3 4 szt.	
	LAP23L		2290	917	1105	92.6 kg 0.395 m3 5 szt.	blat zawsze z nogą NE41, kolor M015 - biały półmat
	LAL13L		1290	917	1105	51.6 kg 0.223 m3 4 szt.	
	LAL16L		1590	917	1105	65.35 kg 0.27 m3 4 szt.	
	LAL23L		2290	917	1105	92.5 kg 0.395 m3 5 szt.	blat zawsze z nogą NE41, kolor M015 - biały półmat
	LAU11L		1000	1114	740	37.75 kg 0.123 m3 3 szt.	
	LAU18L		800	1114	740	30.5 kg 0.1 m3 3 szt.	

Dodatkowa dopłata							
Półka pod monitor x1	Półka pod monitor x 2						
X							
X							
X							
X							
X							
X							
	X						

Elementy składowe proste							
	Symbol		Wymiary			Waga Obj. Opak.	Uwagi
			Szer.	Gł.	Wys.		
	LAU21L		1000	917	740	29.5 kg 0.117 m3 3 szt.	element niski z cofniętym frontem
	LAU28L		800	917	740	27.5 kg 0.095 m3 3 szt.	
Elementy składowe łukowe							
	LAV62L		2216	917	1105	74.65 kg 0.758 m3 5 szt.	blat zawsze z nogą NL41, kolor M015 - biały półmat
	LAV64L		1600	917	1105	61.05 kg 0.671 m3 4 szt.	
	LAV90L		2264	917	1105	107.75 kg 1.043 m3 5 szt.	
	LAV70L		1297	917	1105	39.5 kg 0.361 m3 4 szt.	
	LAV63L		1225	917	1105	52.55 kg 0.502 m3 4 szt.	
	LAV65L		1311	1165	740	34.5 kg 0.291 m3 3 szt.	
	LAV66L		1720	1109	740	49.65 kg 0.446 m3 3 szt.	

Dodatkowa dopłata							
Półka pod monitor x1							
X							
X							
X							

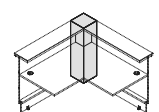
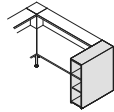
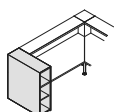
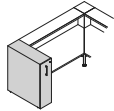
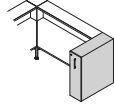



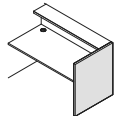
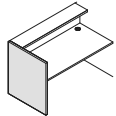
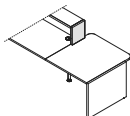
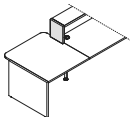
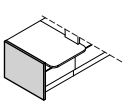
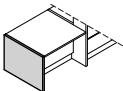
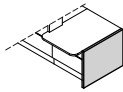
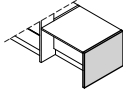

Dodatkowa dopłata

Elementy składowe łukowe							
	Symbol		Wymiary			Waga Obj. Opak.	Uwagi
			Szer.	Gł.	Wys.		
 	LAV68L		1485	1109	740	33.5 kg 0.26 m ³ 3 szt.	
 	LA90L		1296	616	1105	35.5 kg 0.147 m ³ 2 szt.	
Elementy składowe							
	LA100		300	300	1105	20.85 kg 0.115 m ³ 1 szt.	"kostka zamknięta" narożna
	LAP10		318	917	1105	50 kg 0.364 m ³ 1 szt.	kostka z regalem prawa, zawiasy obiektywne
	LAL10		318	917	1105	50 kg 0.364 m ³ 1 szt.	kostka z regalem lewa, zawiasy obiektywne
	LAC10L		318	917	1105	70 kg 0.388 m ³ 1 szt.	kontener Cargo, lewy
	LAC10P		318	917	1105	70 kg 0.388 m ³ 1 szt.	kontener Cargo, prawy
	LAD10		306	20	1094	6 kg 0.011 m ³ 1 szt.	drzwi uniwersalne do LAP10 i LAL10



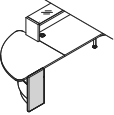
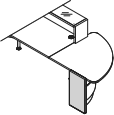

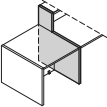
--	--	--	--	--	--	--	--

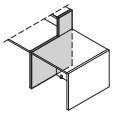
Elementy składowe							
	Symbol		Wymiary			Waga Obj. Opak.	Uwagi
			Szer.	Gł.	Wys.		
	LAN1P		38	917	1105	29.9 kg 0.051 m ³ 1 szt.	bok lady wysokiej - prawy
	LAN2L		38	917	1105	29.5 kg 0.051 m ³ 1 szt.	bok lady wysokiej - lewy
	LAN3P		38	300	364	4 kg 0.007 m ³ 1 szt.	bok do łączenia lady niskiej i wysokiej, prawy
	LAN4L		38	300	364	3.6 kg 0.007 m ³ 1 szt.	bok do łączenia lady niskiej i wysokiej, lewy
	LAN5P		38	917	740	20 kg 0.036 m ³ 1 szt.	noga do lady niskiej, prawa
	LAN11P		38	917	740	17 kg 0.032 m ³ 1 szt.	
	LAN6L		38	917	740	20.5 kg 0.036 m ³ 1 szt.	noga do lady niskiej, lewa
	LAN11L		38	917	740	17 kg 0.032 m ³ 1 szt.	

Dodatkowa dopłata

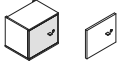
Elementy składowe							
	Symbol		Wymiary			Waga Obj. Opak.	Uwagi
			Szer.	Gł.	Wys.		
	LAN7P		38	374	1105	13 kg 0.024 m3 1 szt.	bok lady wysokiej - prawy
	LAN8L		38	374	1105	12.5 kg 0.024 m3 1 szt.	bok lady wysokiej - lewy
	LAN9L		38	374	740	8.4 kg 0.013 m3 1 szt.	
	LAN9P		38	374	740	8.3 kg 0.013 m3 1 szt.	
	LAN10L		38	917	1105	22.65 kg 0.051 m3 1 szt.	
	LAN13L		38	917	1105	22.65 kg 0.051 m3 1 szt.	
	LAN10P		38	917	1105	22.5 kg 0.051 m3 1 szt.	
	LAN13P		38	917	1105	22.65 kg 0.052 m3 1 szt.	

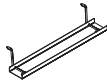
Dodatkowa dopłata

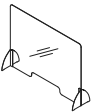
Elementy składowe							
	Symbol		Wymiary			Waga Obj. Opak.	Uwagi
			Szer.	Gł.	Wys.		
	LMS05		345	283	314	6.8 kg 0.031 m3 1 szt.	
	LMS06		339	18	286	2.25 kg 0.005 m3 1 szt.	
	NL41		585	142	712	2 kg 0.063 m3 1 szt.	noga okrągła
	NE41L		40	40	712	1.5 kg 0.002 m3 1 szt.	noga okrągła
	E64L		460	89	120	0.5 kg 0.001 m3 1 szt.	kanał kablowy M009 - aluminium półmat
	S69L		580	162	123	1 kg 0.015 m3 1 szt.	09 - aluminium
	S81L		140	70	750	1.1 kg 0.008 m3 1 szt.	przewodzenie kabli (kręgosłup), 09 - aluminium
	NPX1		1000	250	750	8.8 kg 0.01 m3 2 szt.	nadstawka ochronna, tworzywo PET bezbarwne + stopki metalowe, kolor: M009 - aluminium półmat

Dodatkowa dopłata							